

US - 22619 P01

Sipariş Kodu: 2223-259

US
AIR SPRING

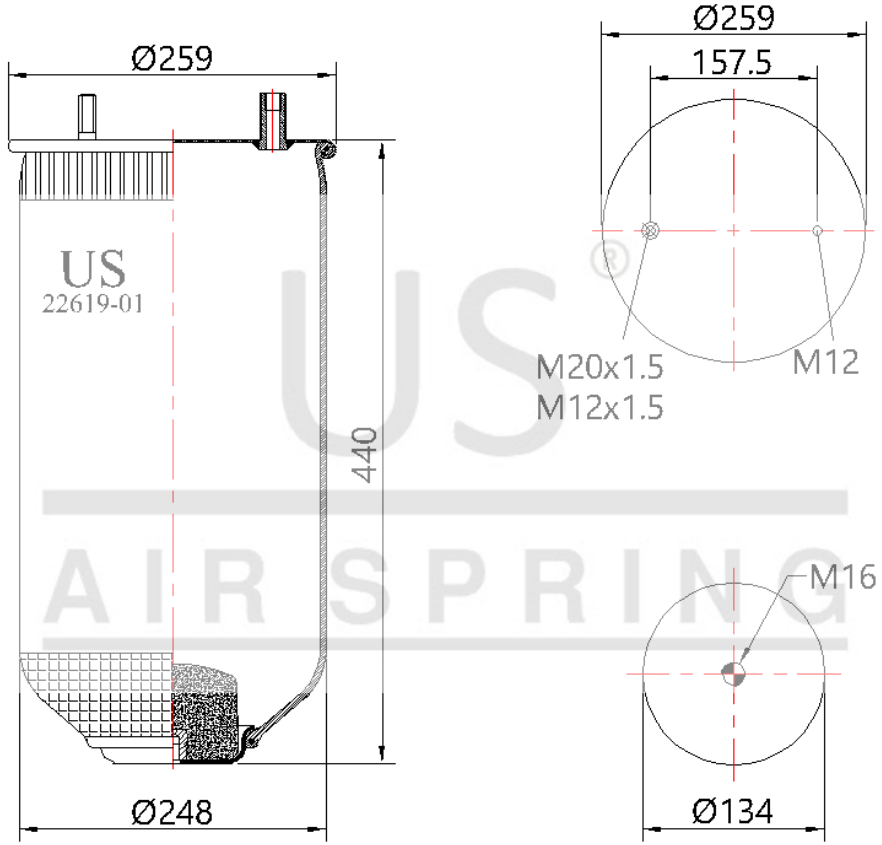

© 2026 US AIR SPRING. ALL RIGHTS RESERVED. <http://www.usmerkaucuk.com/>

Ürün Özellikleri

Ürün Tipi	P
Ürün Kodu	22619 P01
Sipariş Kodu	2223-259
Kutu Boyutu	780*1180*560
Kutudaki Adet	20 PCS
Ağırlık	5,09 Kg.
Tork	
Ürün Grubu	

US - 22619 P01

Sipariş Kodu: 2223-259



CROSS Kodları

CONTITECH	4022NP08
AIRTECH	3261901KPP
NEOTEC	ABM52030F11
PHOENIX	1DK22E16
PRIME RIDE	1R11936
PRIME RIDE	566223526

OEM Kodları

SAF	3228104300
SAF	3229004300